

Nice

OXILR
OXILR/A

Radio receiver



EAC
made in Italy

EN - Instructions and warnings for installation and use

Nice

1 PRODUCT DESCRIPTION

OXILR (OXILR/A) is a radio receiver designed for being installed on a control unit for automating gates, garage doors and road barriers.

⚠ – All uses other than the intended use described and use in environmental conditions other than those described in this manual should be considered improper and forbidden!

WARNINGS

This device must be professionally installed. The only permitted antenna is a 17 cm whip included. Changeable antenna that must be professionally installed. For the OXILR/A do not use the coaxial cable but connect the whip cable included.

• Long-range two-way radio communication

The OXILR (OXILR/A) receiver is equipped with two-way radio technology guaranteeing “Long Range” radio communication and interfaces with two-way transmitters that adopt the “LR” two-way radio encoding system. OXILR (OXILR/A) can both receive and transmit information from and to the transmitter and, in particular, includes the following functions:

- the sending of the confirmation (to the transmitter) that the transmitted command was received correctly;
- the sending of the status (to the transmitter) of the automation (for example, whether the gate is open or closed, or any anomalies present).



• Other product characteristics



- The receiver is compatible with the “LR” two-way encoding system.
- The control unit’s receiver has **1024 memory locations** to memorise transmitters: one location can alternatively memorise a single transmitter (if its keys are memorised as a “single set”, with the Mode 1 procedures

- read Paragraph 3.1), or a single key (if memorised with the Mode 2 procedures – read Paragraph 3.2).
 - This receiver can be used solely with control units equipped with “SM”-type plug connector (verify the most suitable control units on the Nice product catalogue or on the www.niceforyou.com website).
 - This receiver automatically recognises the characteristics of the control unit on which it is installed and self-sets in the following way:
 - If the control unit manages the “BusT4”, the receiver makes available up to 15 different commands.
 - If the control unit DOES NOT manage the “BusT4”, the receiver makes available up to 4 different commands.
- Important!** – In both cases, the number and diversity of the available commands depend on the type and model of the control unit adopted. The “Table of commands” of each control unit is shown in the respective instruction manual.

2 INSTALLATION AND CONNECTION

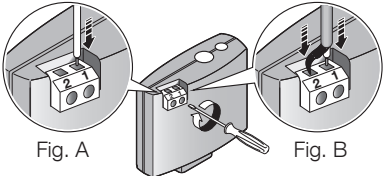
The receiver must be connected to the control unit by inserting it through the relevant slot:

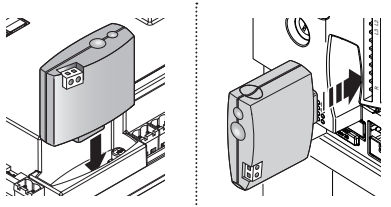

<p>01.  Before inserting (or removing) the receiver, disconnect the power supply to the control unit.</p>	
<p>02. Connect the <u>antenna supplied</u> to terminal 1 of the receiver, as shown in Fig. A. Alternatively, if the radio signal reception must be improved through the installation of an external antenna with a coaxial cable with 50Ω impedance (type RG58), the coaxial cable must be connected <u>directly to terminals 1 and 2 of the receiver (Fig. B)</u>, ignoring the “antenna” terminal (if present) on the control panel.</p>	

<p>03. Insert the receiver through the relevant opening on the control unit.</p>	
<p>04. Restore the power supply to the control unit.</p>	<p>ON</p> 

3

MEMORISING / DELETING TRANSMITTERS IN THE RECEIVER

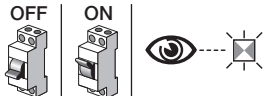
Verification of the TYPE OF ENCODING system adopted by the transmitters already memorised

<p>01. Disconnect the power supply to the control unit then restore the power supply and count the number of flashes emitted by LED B on the receiver:</p>	<p>OFF ON</p> 
<p>• 1 orange flash = transmitters with LR technology</p>	

• 5 green flashes and 1 orange flash = no transmitter memorised







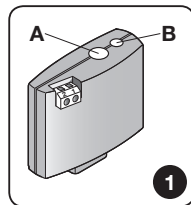

WARNINGS for carrying out the programming procedures

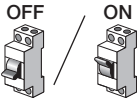

• During the execution of the **programming procedures**, refer to Fig. 1 to identify key A and LED B on the receiver. • To understand the meaning of the icons featured in the procedure, refer to the table, “Key to the symbols used in the manual”. • The procedures have a limit time; therefore, before implementing them, it is important to read and understand all the steps to be completed.



KEY TO THE SYMBOLS USED IN THE MANUAL

Symbol	Description
	(on the receiver) LED “B” STEADY LIT
	(on the receiver) LED “B” LONG FLASH
	(on the receiver) LED “B” QUICK FLASH
	(on the receiver) LED “B” OFF

	Disconnect power supply / Restore power supply
	Wait ...
> 5 sec <	Perform the operation within 5 seconds ...
	Hold down key "A" of the receiver
	Press and release key "A" of the receiver
	Release key "A" of the receiver
	Press and release the desired transmitter key
	Hold down the desired transmitter key

	Release the desired transmitter key
	Read the control unit's instruction manual
	Observe when LED "B" emits signals

The system can be programmed in Mode 1 or in Mode 2: see Paragraphs 3.1 and 3.2.

3.1 - Memorisation in “Mode 1”

While Procedure 1 is being carried out, the receiver memorises all the command keys present on the transmitter, automatically assigning output 1 of the receiver to the 1st key, output 2 to the 2nd key, and so forth. Once the procedure terminates, the memorisation will occupy a single memory location and the command associated with each key will depend on the “List of commands” present on the automation’s control unit.

PROCEDURE 1 - Mode 1 memorisation

01. **On the receiver:** hold down key A and wait for the green LED B to light up. Subsequently, release key A.

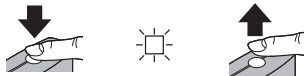



02. **On the transmitter being memorised:**
(within 10 seconds) on the transmitter: press and immediately release any command key; LED B (on the receiver) will flash green 3 times (=memorisation completed correctly). **(*1)**



(*1) Note - If there are other transmitters to be memorised, repeat step 02 within the next 10 seconds. The procedure will terminate automatically once this time elapses.

3.2 - Memorisation in “Mode 2”

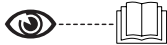
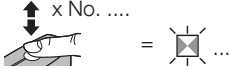
While Procedure 2 is being carried out, the receiver memorises a single key among those present on the transmitter, associating it with the receiver output chosen by the installer. To memorise further keys, repeat the procedure from the beginning for each key to be memorised. Once the procedure terminates, the memorisation will occupy a single memory location and the command associated with the memorised key will be that chosen by the installer from the “List of commands” of the automation’s control unit. **Note** - A key can be associated with only one output, while the same output can be associated with multiple keys.

PROCEDURE 2 - Mode 2 memorisation (and extended Mode 2)	
<p>01. In the control unit manual: choose the command to be memorised and remember its “identification number”.</p>	
<p>02. On the receiver: press and release key A for a number of times matching the <u>number that identifies the command chosen at step 01</u>: LED B will flash the same number of times.</p>	
<p>03. On the transmitter with the key to be memorised: (within 10 seconds) on the transmitter: <u>press and immediately release</u> the key to be memorised; LED B (on the receiver) will flash green 3 times (= memorisation completed correctly). (*2)</p>	
<p>(*2) Note - If there are other keys to be memorised (belonging to other transmitters) <u>with the same command</u>, repeat step 03 within the next 10 seconds for each further key to be memorised (the procedure terminates once this time elapses).</p>	

3.3 - Memorising (in the receiver) the control unit Series/Address, for the BusT4 network

The OXILR (OXILR/A) receiver can interact with a single control unit through the “BusT4” network. If the system contains multiple control units connected to each other via “BusT4”, before carrying out the following procedure the cable of the “BusT4” network must be disconnected from the control unit on which the Series/Address will be memorised.

PROCEDURE 4 - Memorising (in the receiver) the control unit Series/Address, for the BusT4 network

01. Disconnect the power supply and wait 5 seconds.

OFF



5 s

02. Hold down key A of the receiver and simultaneously restore the power supply:
LED B emits some initial flashes (Chapter 3); it will then emit 2 short orange flashes; lastly, when the steady green light appears (***3**), release key A.



ON

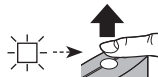

(*3) Note - If the LED emits a steady red light, it means that the memorisation procedure was not completed. In this case, repeat the procedure from the beginning.

⚠ WARNING! - Once the Series/Address has been memorised, the receiver will drive the control unit only through BusT4. The Stand-By function cannot be active on the control unit. To enable the Stand-By function on the control unit, do not run the “Memorising the control unit Series/Address for the BusT4 network” procedure.

3.4 - Deleting the receiver's memory (fully or partially)

PROCEDURE 5 - FULL or PARTIAL deletion of the receiver's memory

01. **On the receiver:** hold down key A and observe the status of the green LED B: after 6 seconds it will light up then switch off. After a few seconds it will start flashing; then immediately choose the type of desired deletion:
- > **to delete ALL the transmitters:** release key A exactly at the **3rd flash**
- > **to delete ALL THE RECEIVER'S MEMORY:** release key A exactly at the **5th flash**
- > **to delete (in the receiver) the Series/Address of the control unit, for the BusT4 network:** release key A exactly at the **7th flash**



This function can be performed also using the O-Box / O-View programmers.

3.5 - Deleting a SINGLE transmitter or a SINGLE key from the receiver memory

PROCEDURE 6 - Deleting a SINGLE transmitter or a SINGLE key from the receiver memory

01. **On the receiver:** hold down key A, observe the green LED B light up and move to step 02 when it switches off.



02. **On the transmitter to be deleted:**
(on the transmitter) press and release the key to be deleted **(*4)**: LED B (on the receiver) will emit 5 quick green flashes (= deletion completed correctly).



(*4) Note - If the transmitter is memorised in “Mode 1”, any key can be pressed. If the transmitter is memorised in “Mode 2”, the entire procedure must be repeated for each memorised key that must be deleted.

This operation can also be performed through the O-Box / O-View programmers.

4 OTHER FUNCTIONS

4.1 - Blocking access (through password) to the receiver programming

This function activates in the receiver (with the O-Box programmer) a password consisting of maximum 10 characters, chosen by the installer. The function allows for protecting all the settings already effected in the receiver; moreover, it also prevents any subsequent settings through key A of the receiver (Fig. 1) or through the O-Box and O-View programmers, if the password is not known.

OXILR (OXILR/A)	
Product type	Two-way receiver
Decoding	“LR”
Input impedance	50 Ω
Reception frequency	OXILR: 433.75 MHz; OXILR/A: 915.75 MHz
Transmission frequency	OXILR: 433.75 MHz; OXILR/A: 915.75 MHz
Outputs	4 (on “SM” plug-type connector)
Sensitivity	-120 dBm
Absorption	50 mA (maximum)
Radiated power (ERP)	< 10 mW (OXILR)
Dimensions (mm)	W 49.5; H 41.9; D 18
Weight (g)	22
Operating temperature	-20 °C ... +55 °C

• Notes on the product technical specifications

- The reception capacity of the receivers and the transmitter range are strongly affected by other devices (e.g. alarms, headphones, etc.) operating on the same frequency in your area. Nice cannot provide any guarantee with regard to the actual range of its devices under such conditions.
- All technical specifications stated herein refer to an ambient temperature of 20°C ($\pm 5^\circ\text{C}$).
- Nice reserves the right to apply modifications to the product at any time when deemed necessary, without

altering the intended use and functions of the product itself.

6 PRODUCT DISPOSAL

This product constitutes an integral part of the automation and, therefore, must be disposed of together with it.

Similarly to the installation phase, once the product reaches the end of its useful life, the disassembly and scrapping operations must be performed by qualified personnel. This product is made of various types of materials, some of which can be recycled while others must be scrapped. Seek information on the recycling and disposal systems envisaged by local regulations in your area for this product category.

⚠ WARNING! - Some parts of the product may contain polluting or hazardous substances which, if released into the environment, constitute serious environmental and health risks.

As indicated by the adjacent symbol, the product may not be disposed of together with domestic waste. Sort the materials for disposal, according to the methods envisaged by current legislation in your area, or return the product to the retailer when purchasing an equivalent product.



⚠ WARNING! - Local regulations may envisage the application of heavy fines in the event of improper disposal of this product.

COMPLIANCE WITH THE FCC RULES (PART 15) AND WITH RSS-210 RULES

This device contains licence-exempt transmitter(s)/receiver(s) that comply with Innovation, Science and Economic Development Canada's licence-exempt RSS(s); and with Part 15 of the FCC rules of the United States of America. Operation is subject to the following two conditions: (1) This device may not cause interference. (2) This device must accept any interference, including interference that may cause undesired operation of the device.

Any changes or modifications made to this device, without the express permission of the manufacturer, may void the user's authority to operate this device.

SIMPLIFIED EU DECLARATION OF CONFORMITY

Hereby Nice S.p.A. declares that the radio equipment type OXILR is in compliance with Directive 2014/53/EU.

The full text of the EU declaration of conformity is available at the following internet address: <https://www.niceforyou.com/en/support>

Signals emitted by LED B of the receiver**Long flashes > GREEN****On start-up:**

5 * = No remote control memorised

During operation:

1 * = Indicates that the code received is not stored in the memory

3 * = Saving code in memory

5 * = Memory deleted

6 * = During programming, indicates that the code is not authorised for memorisation

8 * = During programming, indicates that the memory is full

Short flashes > GREEN

1 * = Undefined

2 * = Undefined

4 * = Output in "Mode 2" not managed on control unit

5 * = During the deletion procedure, indicates that the code has been deleted

6 * = Code synchronisation failure

Long flashes > RED

1 * = Undefined

2 ✱ = Undefined

Short flashes > RED

1 ✱ = Undefined

1 ✱ = Undefined

2 ✱ = Undefined

Long flashes > ORANGE

1 ✱ = (on start-up, after a few green flashes) indicates the presence of two-way transmitters

Short flashes > ORANGE

2 ✱ = Undefined



Nice

Nice S.p.A.

Via Callalta, 1
31046 Oderzo TV Italy
info@niceforyou.com

www.niceforyou.com